

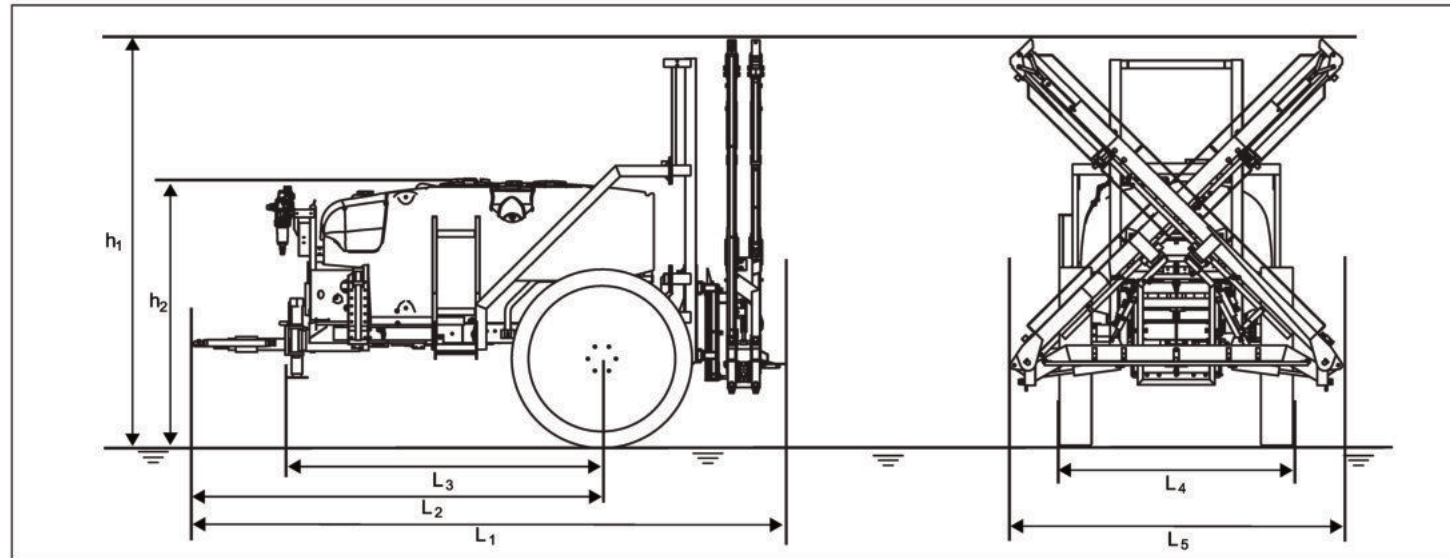

- Pompa bassa pressione da 160 a 250 BP It/min
- Low pressure pump from 160 to 250 BP It/min
- Niederdruck-Pumpe von 160 zu 250 BP It/min
- Pompe basse pression de 160 au 250 BP It/min
- Valvola per lo svuotamento totale
- Total bleed valve
- Gesamtentleerungsventil
- Valve de vuidage total



	m	Kg	cm							Sections	Nr.			
			L ₁	L ₂	L ₃	L ₄	L ₅	H ₁	H ₂					
FCD 15	COLIBRI 12/13	1500	4,1	2,8	1,9	1,8	2,5	3	1,75	9,5 - 24	1390	2971	5	24/26
	COLIBRI 14/15	1500	4,1	2,8	1,9	1,8	2,5	3	1,75	9,5 - 24	1583	3164	5	28/30
	COLIBRI 16	1500	4,1	2,8	1,9	1,8	2,5	3,3	1,75	9,5 - 24	1583	3164	5	32
	COLIBRI 18	1500	4,1	2,8	1,9	1,8	2,5	3,3	1,75	9,5 - 24	1703	3284	7	36
	ALBATROS 15	1500	4,1	2,8	1,9	1,8	2,4	3	1,8	9,5 - 24	1498	3079	7	30
FCD 20	COLIBRI 12/13	2000	4,4	3	2,1	1,8	2,5	3	1,8	9,5 - 24	1423	3716	5	24/26
	COLIBRI 14/15	2000	4,4	3	2,1	1,8	2,5	3	1,8	9,5 - 24	1616	3909	5	28/30
	COLIBRI 16	2000	4,4	3	2,1	1,8	2,5	3,3	1,8	9,5 - 24	1616	3909	5	32
	COLIBRI 18	2000	4,4	3	2,1	1,8	2,5	3,3	1,8	9,5 - 24	1736	4029	7	36
	ALBATROS 15	2000	4,4	3	2,1	1,8	2,4	3	1,8	9,5 - 24	1531	3824	7	30

FOR.AGR SRL si riserva la facoltà di introdurre modifiche a dati e caratteristiche senza alcun preavviso. Tutti i dati della tabella sono a titolo indicativo.
FOR.AGR SRL reserves the right to introduce changes to data and features without prior notice. All data in data sheet are indicative.

Rev. 04/2018

VENDITA - ASSISTENZA - CONSULENZA
SALES - SERVICE - CONSULTING

FOR. AGR. s.r.l.
Via Cal Piccole, 25
31044 Montebelluna (TV) Italia
Tel.: +39 0423 601225
Fax: +39 0423 603769
info@favaro.eu
www.favaro.eu

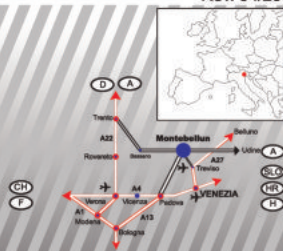





POLVERIZZATORE CARRELLATO - TRAILED FIELD SPRAYERS

FCD 15-20







-  FCD 15-20 Polverizzatore trainato + Barra colibri 12-13-14-15-16-18m / Albatros 15m
-  FCD 15-20 Trailed field sprayers + Colibri booms 12-13-14-15-16-18m / Albatros 15m
-  FCD 15-20 Gezogene Feldspritzen + Colibri balken 12-13-14-15-16-18m / Albatros 15m
-  FCD 15-20 Pulvérisateur trainé + Rampe Colibri 12-13-14-15-16-18m / Albatros 15m



-  Quadro comando principale
-  Main control unit
-  Die Hauptsteuereinheit
-  Unité principale de contrôle







-  Gruppo Elettrico Proporzionale (Elettrovalvole acqua) con scatola comando elettrico
-  Proportional Electric Unit with Electrical Control Box
-  Elektrische Steuereinheit
-  Bloc de commandes électrique

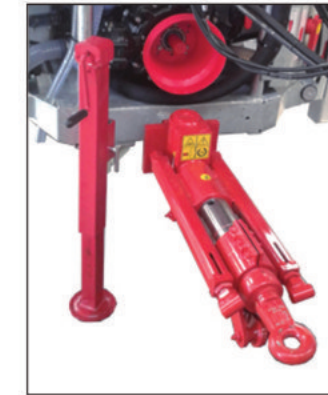





-  Filtro in aspirazione
-  Cover filter
-  Einlass filter
-  Filtre de remplissage

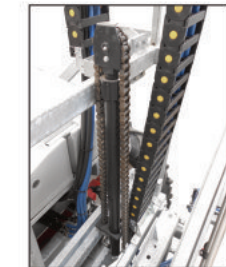





-  Timone a occhio
-  Towing-eye drawbar
-  Lenkdeichsel mit Oesering
-  Direction timon avec anneau







-  Alzo a catena Colibri/Albatros
-  Lifting system with chain for Colibri/Albatros
-  Hydraulischer Hub für Colibri/Albatros
-  Lèvement avec chaîne pour Colibri/Albatros







-  Premiscelatore esterno con lavabarattoli
-  Mixer with container rinsing nozzle
-  Externer Vormischer mit Dosenspüler und automatischem Druck
-  Melangeur







-  Computer DPA
-  Variable rate computer controller
-  Computer
-  Ordinateur



-  Scaletta con maniglie e pedana
-  Ladder with handle and footrest
-  Ladder mit Handles und Fußstütze
-  Échelle avec des poignées et estrade



-  Tracciafile
-  Foam Marker
-  Schaumspuranzeiger
-  Traceur a mousse